

## PRODUCT CHARACTERISTICS

### Applications

The FAM Centris 315 is a compact centrifugal shredder providing a perfect cut quality on a wide range of products, such as:

#### 1. FRUIT & VEGETABLES







Carrots  
Celeriac, onion, cabbage, radish,  
Beetroot, Jerusalem artichokes, taro root  
Green beans  
Mushrooms, tomatoes, green papaya  
Gherkins, cucumber, bamboo, zucchini  
Oranges, lemons, limes, apples

#### 4. POTATOES

Potatoes, sweet potatoes  
Slices flat, crinkle and V-cut  
Shreds

More applications are possible, please contact us.

The maximum product dimensions are 130 mm in length and 95 mm in diameter.

TYPES OF CUTS	CUTTING SIZES	
	Flat cut slices	Various cut sizes available from 0.8 mm up to 5 mm
	Crinkle cut slices	
	V-cut slices	
	V-cut shreds	318V (1.6 mm), 432V (2.5 mm) and 538V (3.2 mm) V-cut shreds
	Julienne shreds	2.4 mm, 4.8 mm, 9.6 mm, 19.05 mm
	Oval cut shreds	Various cut sizes available

#### HAND BATCH FEEDING SPEED

25 kg basket per minute, depending on product, cut size and condition

#### TECHNICAL SPECIFICATIONS

info? [www.fam.be/en/machines](http://www.fam.be/en/machines)

Basic dimensions (l x w x h)	1050 x 750 x 1500 mm
Weight	129 kg
Cutting wheel motor	0.75 kW (1 hp)
In-feed height	1250 mm (50")
Outlet height	540 mm (21")

Have a look at the digital flyer

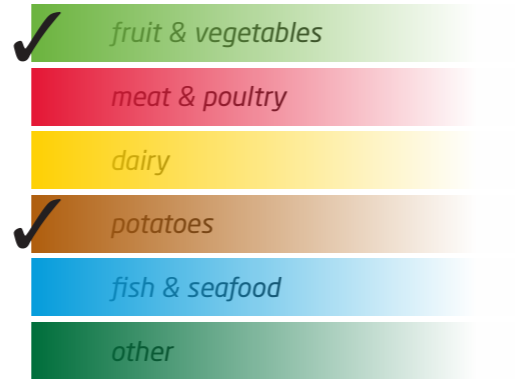

#### Cutting Trials

Worldwide, FAM is ready to advise you in one of its fully equipped test centres. You are invited to send us products for evaluation and you are most welcome to be present during the trials.

#### Find Your Agent

Go to [www.fam.be/en/agents](http://www.fam.be/en/agents) and find all relevant contact data to get in touch with FAM, the regional branch offices and the worldwide agent network.

#### Contacts and Information

For a complete overview of our machines, applications, services and agents, please visit our website. FAM will be happy to respond immediately to your information request.

Please visit [www.fam.be](http://www.fam.be).

#### FAM nv

Neerveld 2 - B-2550 Kontich - Belgium  
t. +32 3 450 92 20 - f. +32 3 450 92 50  
info@fam.be - [www.fam.be](http://www.fam.be)

FAM® and Centris® are registered trademarks by FAM nv.

#### Agent

810145-2014 © FAM nv



Innovative and Compact Centrifugal Shredder



Potato Slices



Cabbage Shreds



Tomato Slices



Carrot Shreds



Onion Rings

Member of  
**HIFFERMAN**  
INDUSTRIAL

Cutting edge solutions for food

# FAM CENTRIS® 315: DESIGNED FOR PERFECT CUT QUALITY, FLEXIBILITY AND SPEED

# A CUTTING EXPERIENCE SECOND TO NONE

FAM has developed the innovative Centris® 315, a new centrifugal slicer & shredder with a high-quality execution at a very attractive price and with the smallest footprint of any industrial centrifugal shredder in the market.

The FAM Centris 315 is designed for companies looking for perfect cut quality, long shelf-life, flexibility and speed while minimizing costs and decreasing the amount of time to complete each job.

The patent pending cutting head technology (\*) guarantees a consistent slice and shred thickness throughout the slicing process. Its unique design considerably facilitates the changing of blades, handling and cleaning.

## Innovative Design Delivering Unbeatable Cut Quality

1. Extremely precise centrifugal cutting principle with new and innovative patent pending cutting head technology.
2. The razor-sharp knives and new, innovative cutting head ensure a perfect cut quality, long-lasting accuracy and very low waste ratio.
3. The 100% stainless steel cutting head weighs 8 kg and has a reduced amount of parts, which improves cleanability and simplifies assembly considerably.

### Cutting Principle

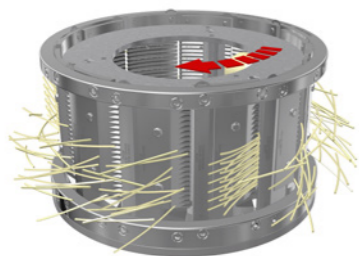

FAM has developed the innovative Centris® 315, a new centrifugal slicer & shredder with a high-quality execution at a very attractive price and with the smallest footprint of any industrial centrifugal shredder in the market.

The FAM Centris 315 is designed for companies looking for perfect cut quality, long shelf-life, flexibility and speed while minimizing costs and decreasing the amount of time to complete each job. The patent pending cutting head technology (\*) guarantees a consistent slice and shred thickness throughout the slicing process. Its unique design considerably facilitates the changing of blades, handling and cleaning.

## Compact Industrial Shredder with High-Quality Execution

4. Operator-friendly machine infeed, designed for hand batch feeding and good working conditions for the machine operator.
5. Large infeed provides uniform product flow to the cutting head and avoids overloading of the head.
6. Rigid, seamlessly welded frame with no flat surfaces. Limited number of bolts used and no exposed threads.
7. The alignment platform for the subframe can hold a wide range of discharge containers with multiple heights.

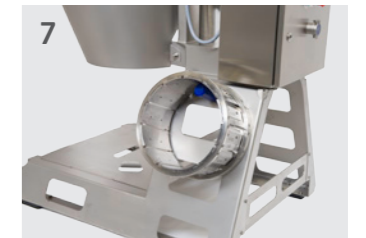
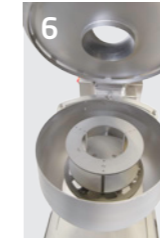
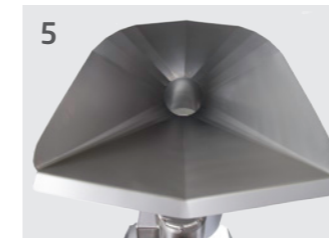
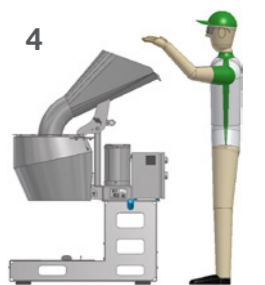

## Designed with Simplicity, Hygiene & Safety in Mind

8. Trapped key interlocking safety system prevents access to the cutting area during machine operation.
9. Heavy-duty cassette style spindle, easily removable for inspection. Life-time greased and sealed roller bearings.
10. Equipped with a 0.75 KW AC three phase stainless steel motor for low energy consumption and designed for easy washdown.
11. Electrical control of the machine is start-stop without programming or read-outs in order to meet simplicity.
12. Designed according to CE, FDA and HACCP regulations. The drive, product and electronics zone are completely separated.

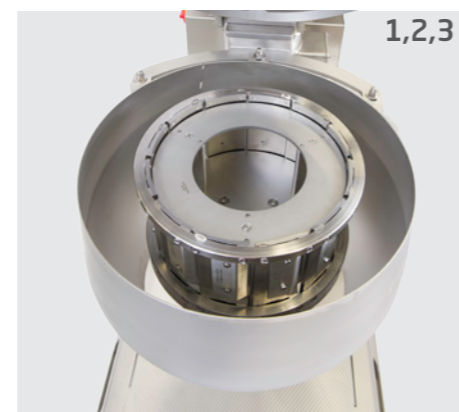
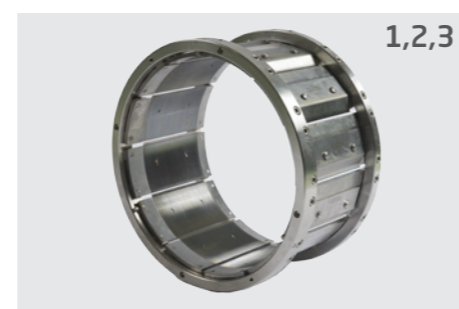
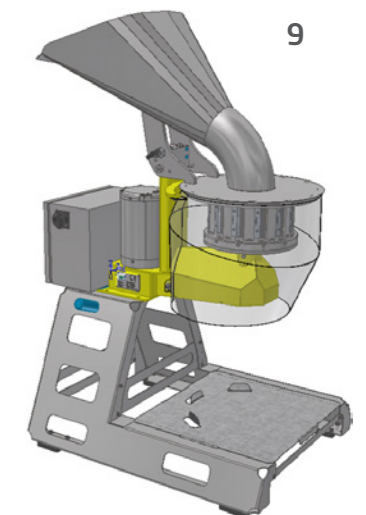

(\*) patent pending impeller and patent pending cutting head assembly